

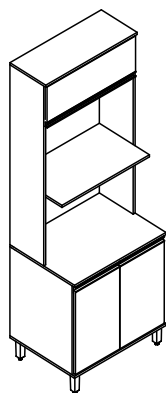

Rodovia SC-492 - Km 10 - B. Industrial
89905-000 - Bandeirante - SC
Fone: (49) 3622-4549
e-mail: mxmoveis@mxmoveis.com.br



Ref. TVI02

*Torre
Cozinha
Cocina
Vicenza*

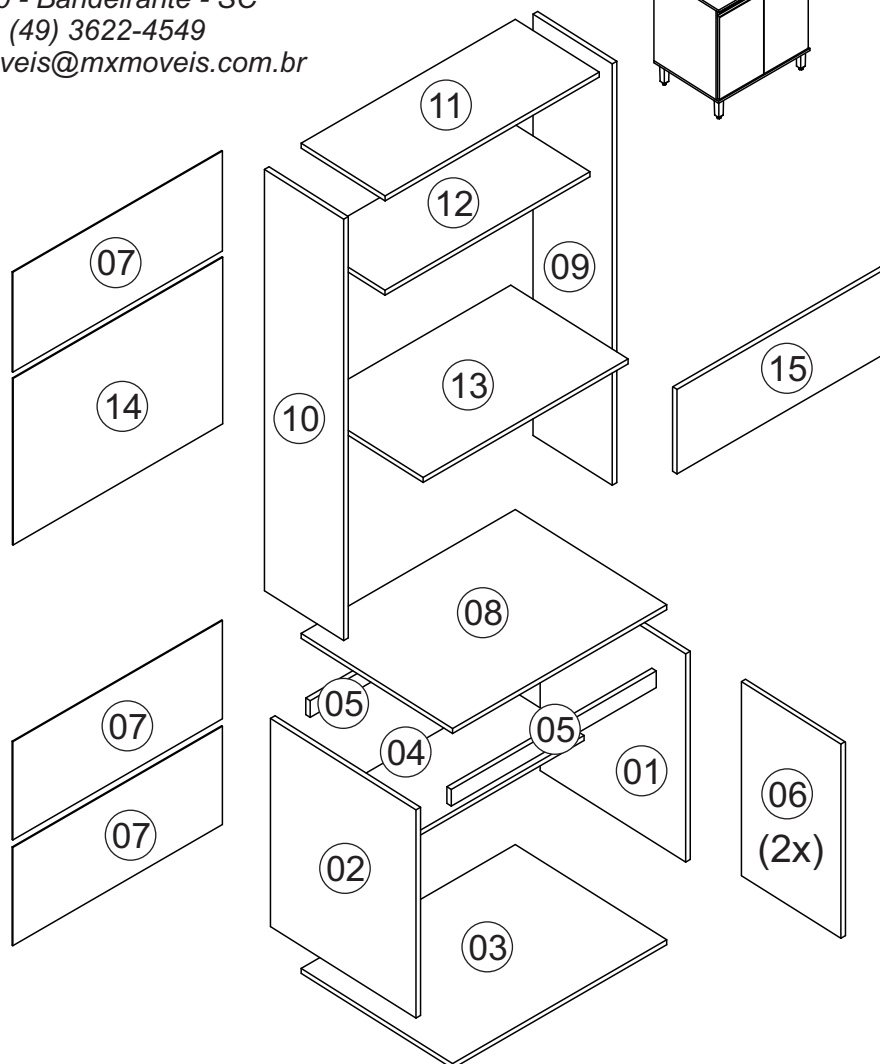

Nº	Código ASSISTÊNCIA	NOME DA PEÇA/DESCRIPCIÓN PIEZAS		QTD.	HAVANA TAUPE	NOGAL NOGAL
01	TVI02.17.01	Lateral balcão direita/Lateral derecha	625x496x15	01	136707	166894
02	TVI02.18.01	Lateral balcão esquerda/Lateral izquierda	625x496x15	01	136708	166895
03	TVI02.01.00	Base inferior/Base inferior	700x516x15	01	132833	166897
04	TVI02.27.00	Prateleira balcão/Repisa inferior	670x250x15	01	136430	136430
05	TVI02.28.00	Ripa sustentação torre/Travesía balcón	670x50x15	02	132835	166899
06	TVI02.25.00	Porta balcão/Puerta balcón	580x339x15	02	137328	166900
07	TVI02.13.00	Forro balcão/Revés balcón	695x300x2,5	03	136433	136433
08	TVI02.33.00	Tampo/Tapa	700x516x15	01	176881	176694
09	TVI02.17.00	Lateral torre direita/Lateral armario derecha	1265x270x15	01	132829	166893
10	TVI02.18.00	Lateral torre esquerda/Lateral armario izquierda	1265x270x15	01	132828	166892
11	TVI02.05.00	Base superior/Base superior	700x286x15	01	132837	166901
12	TVI02.01.01	Base aéreo inferior/Base armário inferior	670x270x15	01	136709	166902
13	TVI02.33.01	Tampo micro/Tapa	670x400x15	01	132834	166898
14	TVI02.13.01	Forro micro/Revés armario	695x502x2,5	01	132840	166904
15	TVI02.25.01	Porta aéreo/Puerta Torre	678x258x15	01	137329	166903

Ferragens/Herrajes

A  **12x**
Cavilha Ø6,0x30mm Cód. 873

B  **24x**
Parafuso 4,0x50mm Cht. Cód. 12537

C  **02x**
Puxador/Manija 339mm Cód. 6559-preto
Cód. 828-bronze

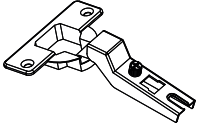
D  **04x**
Dobradiça 26mm Cód. 10269

E  **07x**
Parafuso 4,0x14mm Cht. Cód. 667

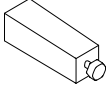
F  **04x**
Pé plástico Cód. 5884
Cód. 5883-preto

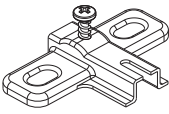
G  **04x**
Calço Dobradiça 26mm Cód. 12539

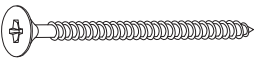
H  **04x**
Parafuso 5,0x50mm Cht. Cód. 1979

I  **08x**
Fixador costa Cód. 7169

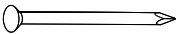
J  **57x**
Prego 8x8 Cód. 822

K  **04x**
Cantoneira metálica Cód. 7168

L  **08x**
Parafuso 3,5x25mm Cht. Cód. 692

M  **01x**
Pistão á gás Cód. 1205

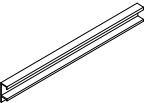
N  **01x**
Puxador/Manija 678mm Cód. 6555-Preto
Cód. 829-Bronze

O  **10x**
Parafuso 3,0x12mm Cht. Cód. 11413

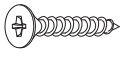
P  **04x**
Parafuso 3,5x40mm Cht. Cód. 691

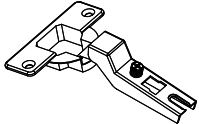
Q  **02x**
Dobradiça 26mm Cód. 10269

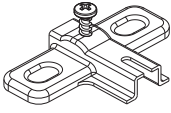
R  **02x**
Calço Alto Dobradiça 26 mm Cód. 18804

S  **24x**
Parafuso 4,0x12mm Cht. Cód. 7604

T  **01x**
Bisnaga cola Cód. 8255

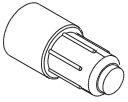

U  **06x**
Suporte prateleira Cód. 790

*Usar os parafusos (L) para unir este módulo a outro.

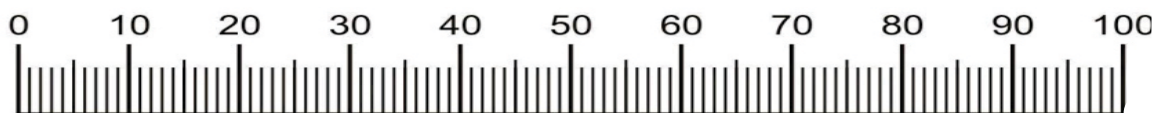
*Usar los tornillos (L) para unirse este módulo a otro.

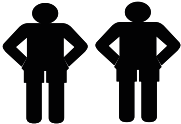

Medidas em mm

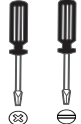
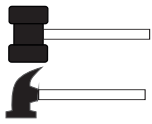
		 1:00		
---	---	---	---	--

 **Giz para madeira**

Produto para ser aplicado em caso de riscos na superfície

Pré-Montagem/Preparación Piezas

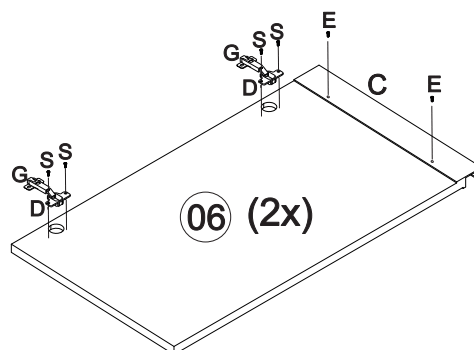
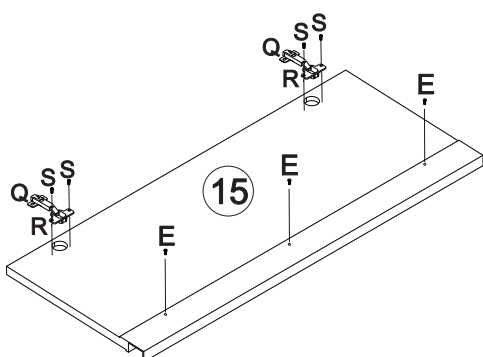
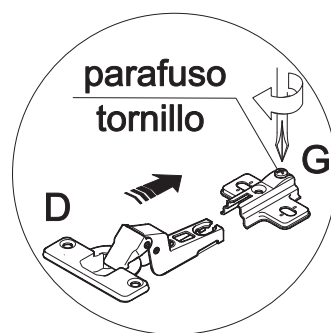
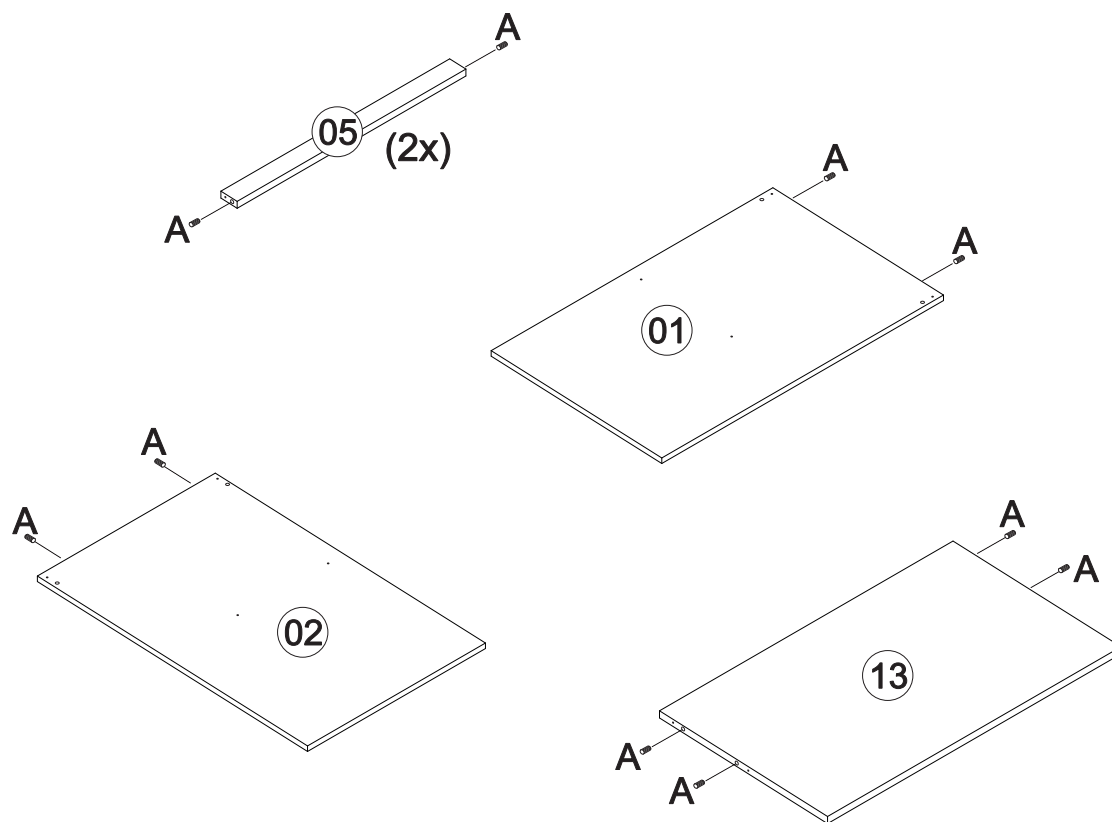

Montagem/Montaje

01

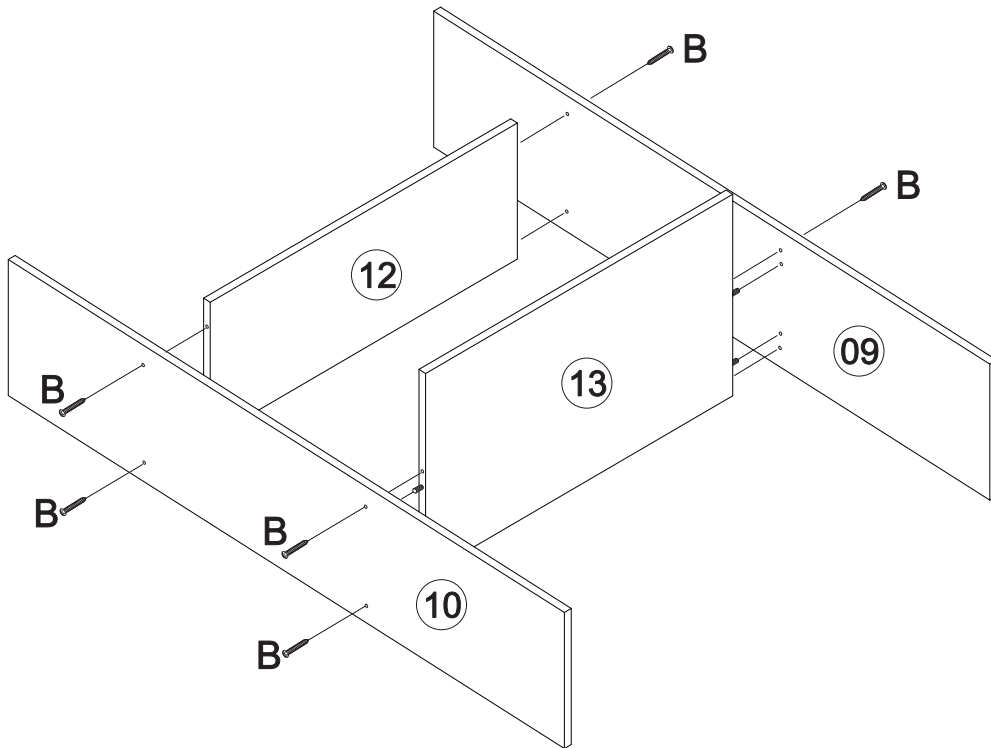

02

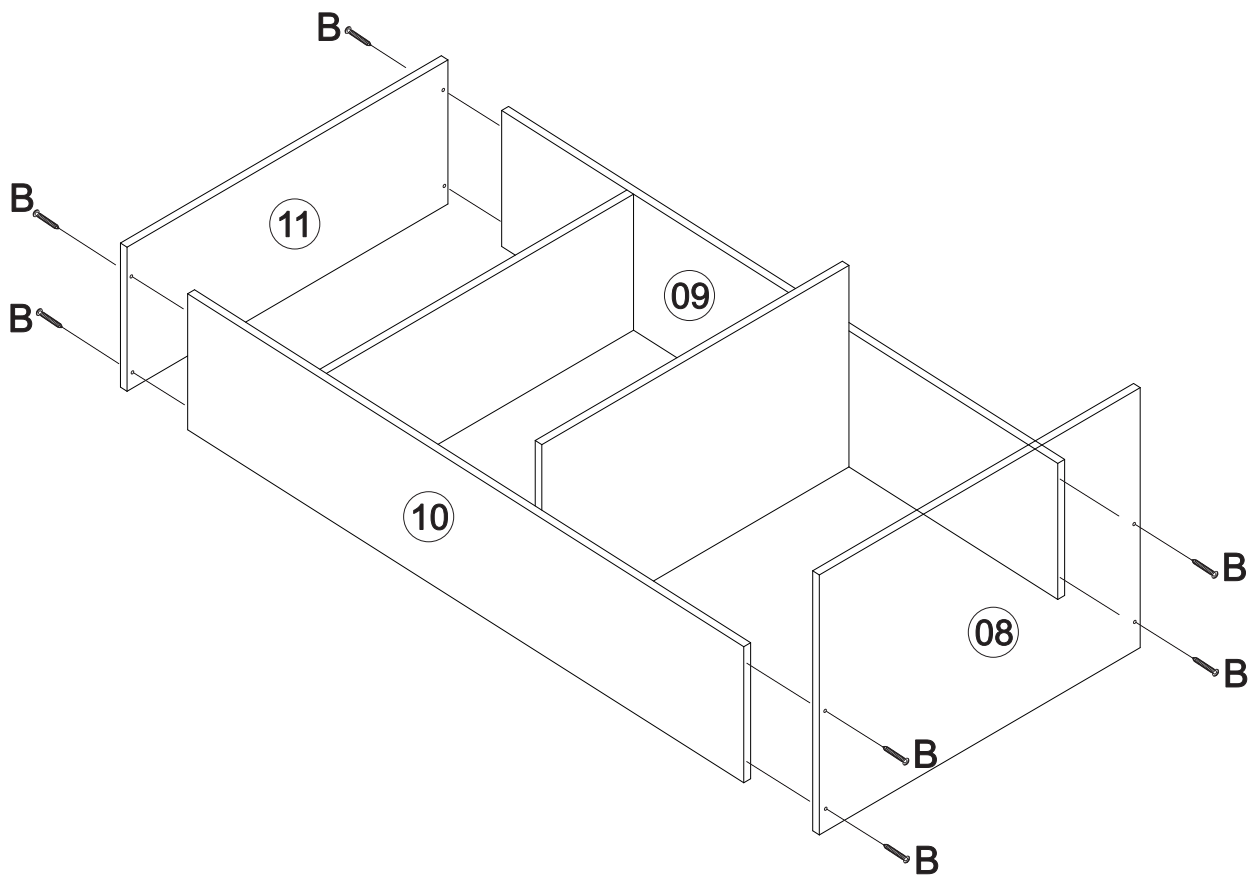

Montagem/Montaje

03

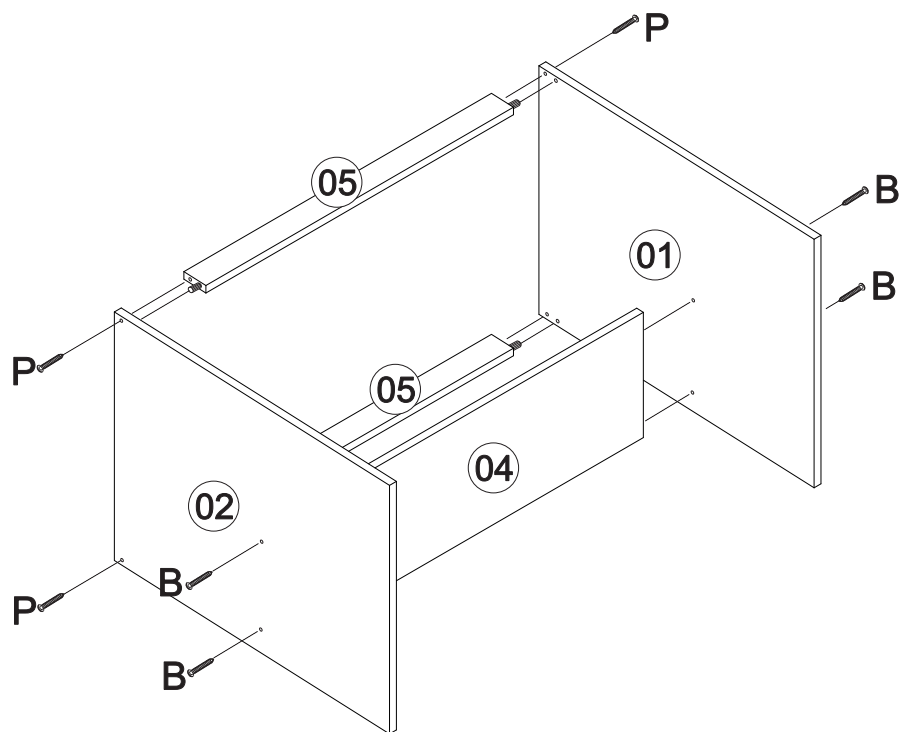

04

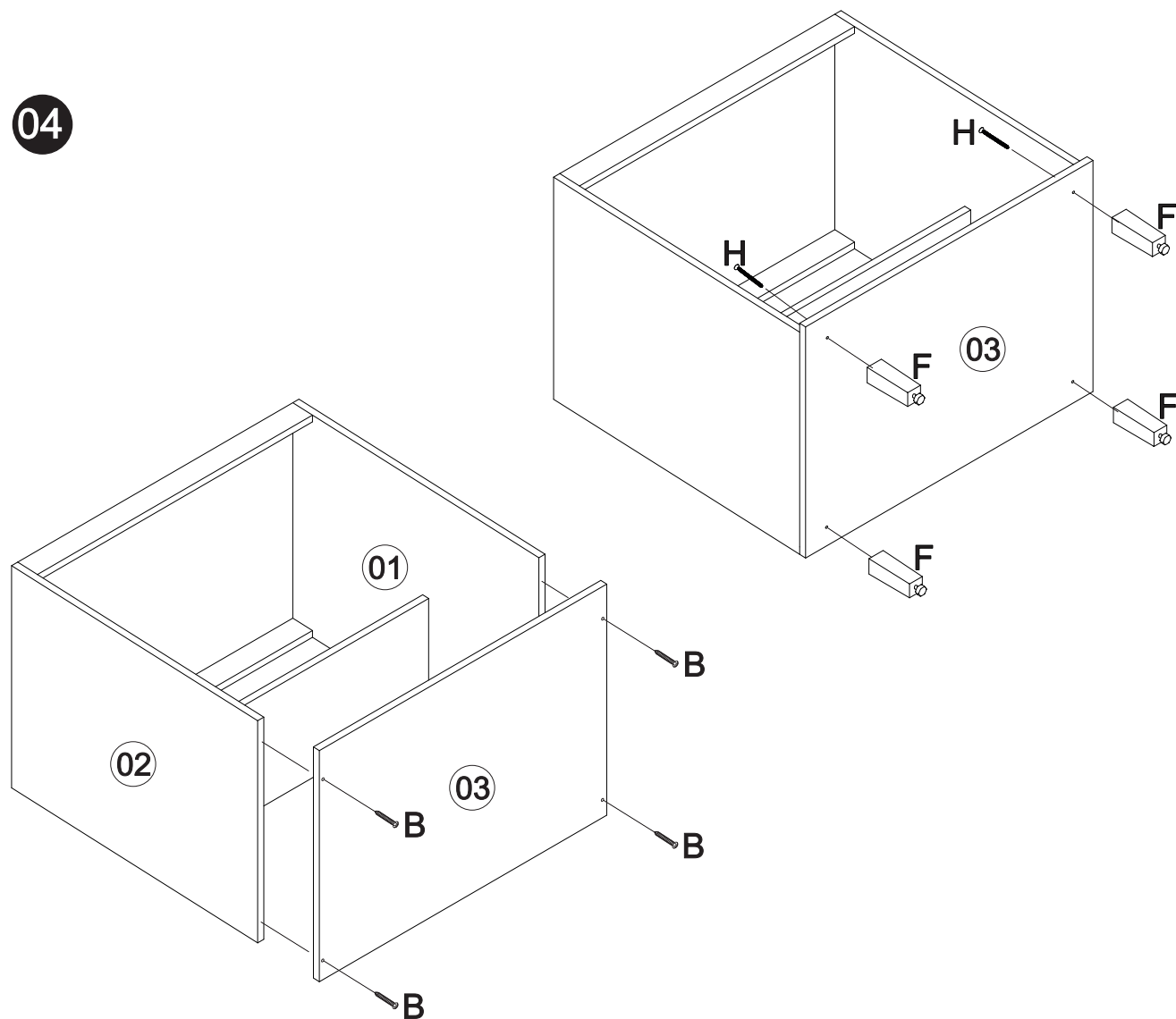

Montagem/Montaje

05

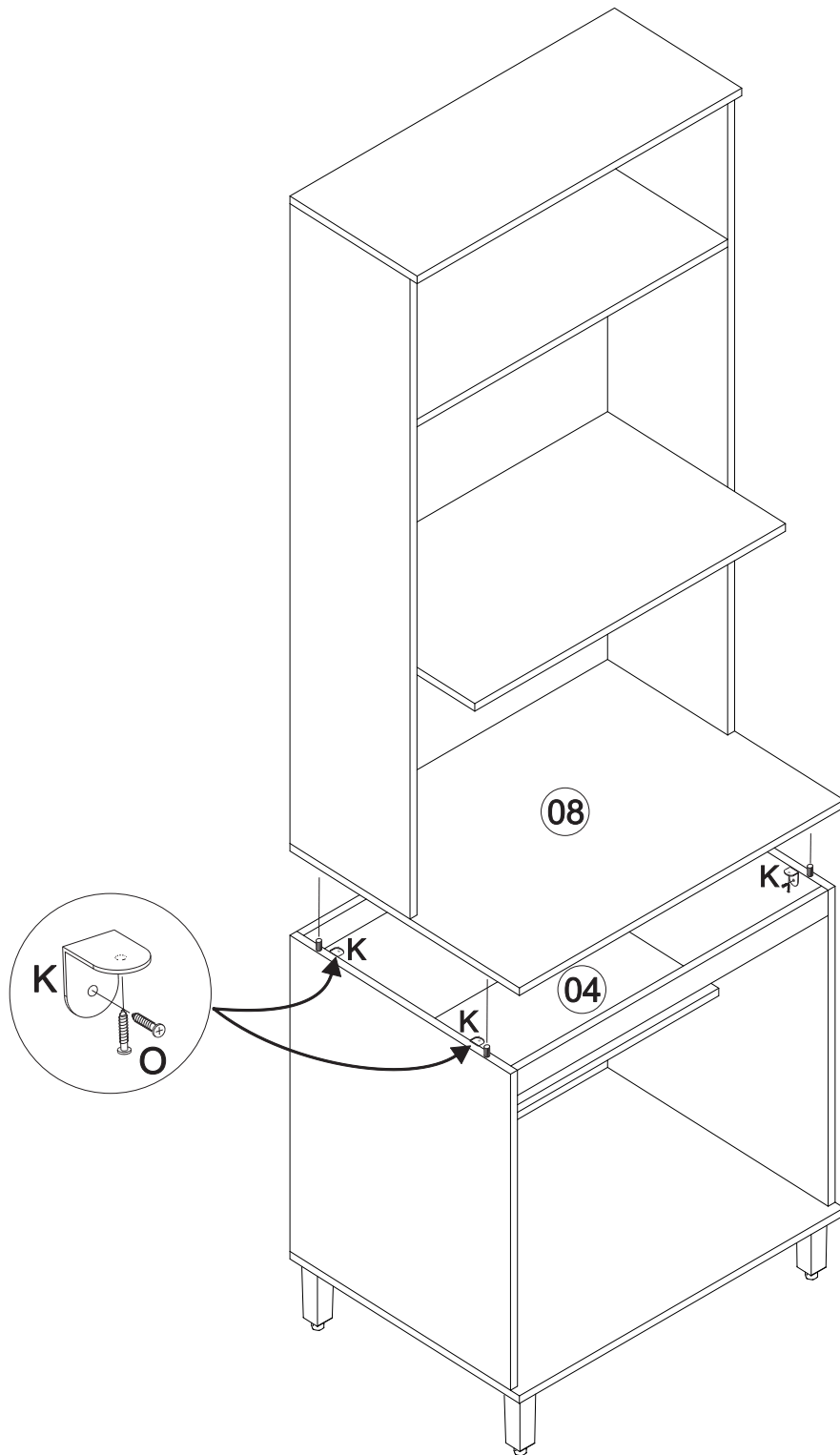

Montagem/Montaje

06

*Usar o prego (J) e a junção (I) a cada 150mm.

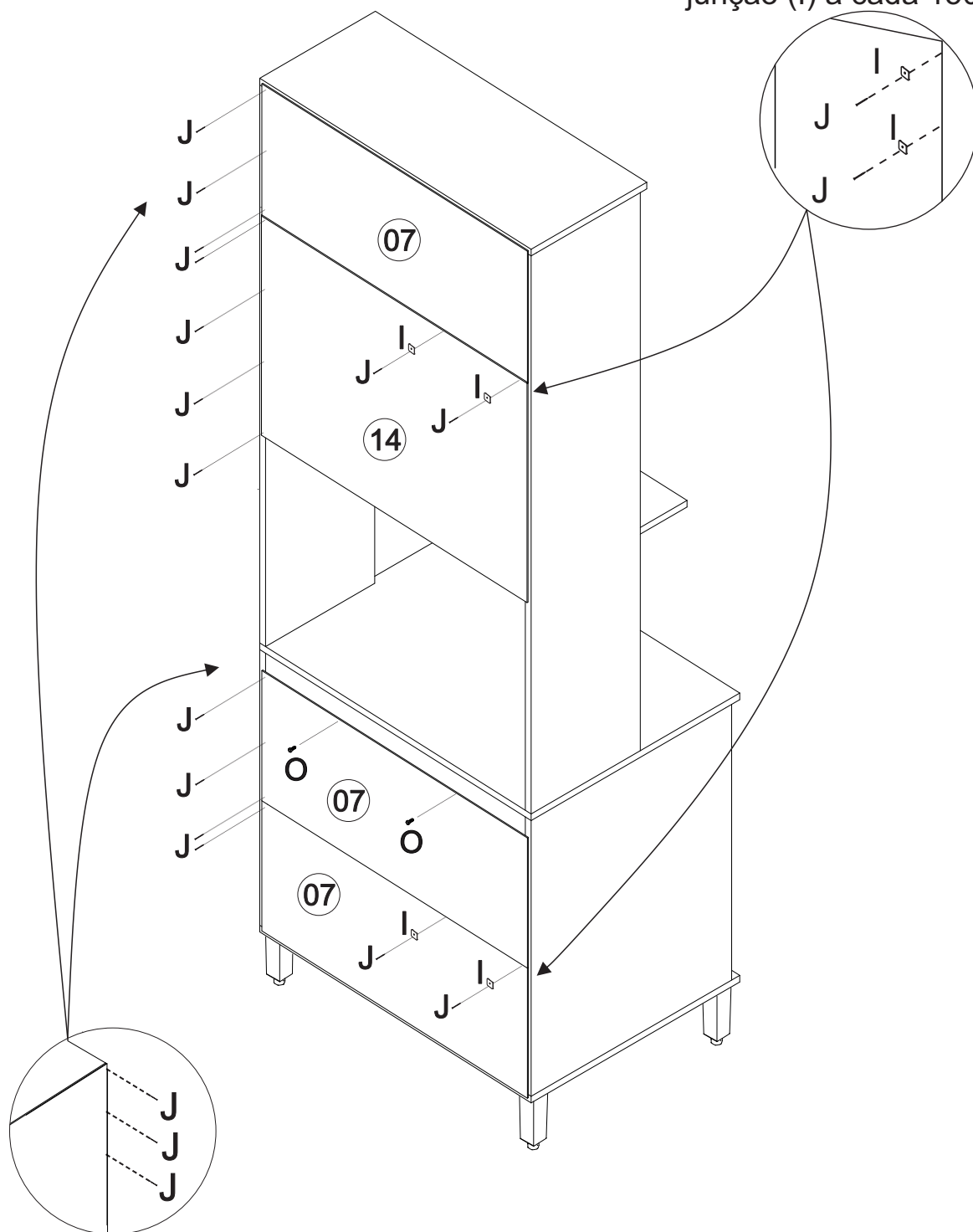

*Colocar um prego (J) a cada 100mm.

Montagem/Montaje

07

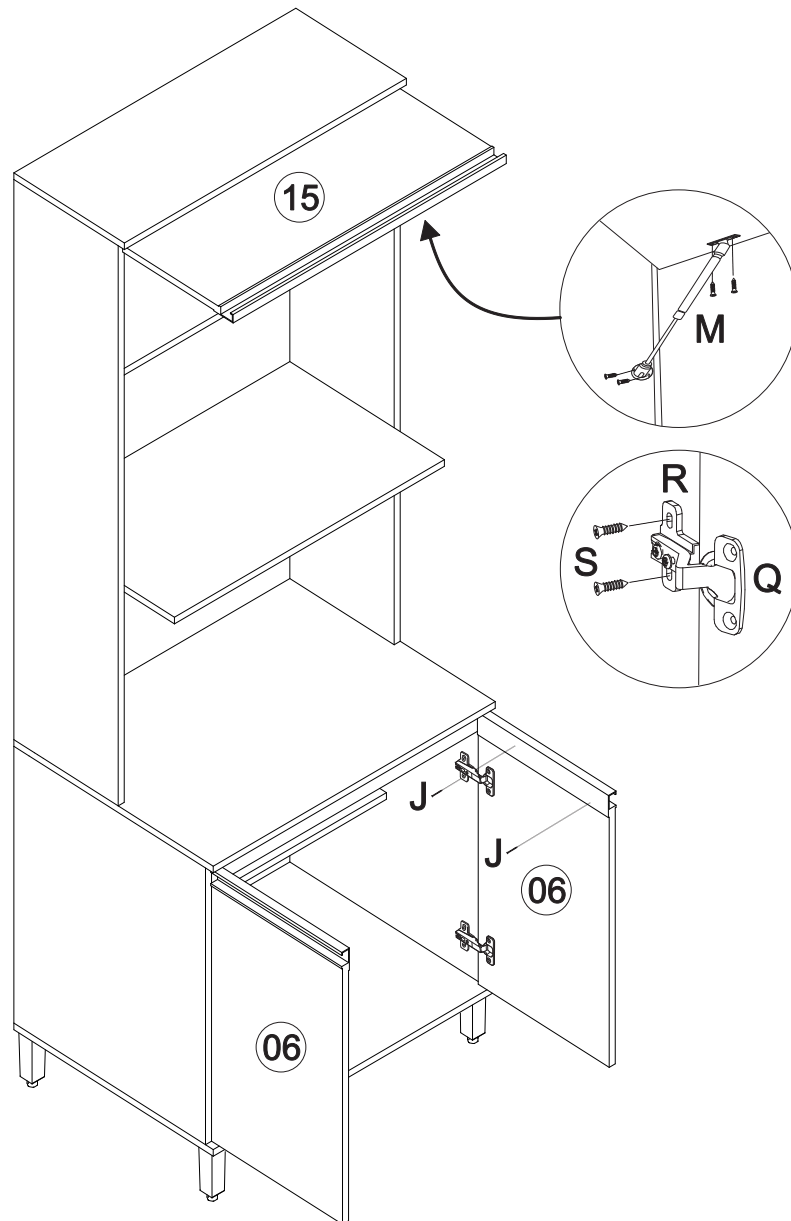

Limpeza/Limpieza

- ☞ Use um pano levemente umedecido com água, seguido de pano seco.
- ☞ Use solamente un paño húmedo con agua y después un paño seco.
- ☞ Nunca utilize produtos químicos ou abrasivos.
- ☞ No utilice productos químicos o abrasivos.